



rousseau MODULAR DRAWER SYSTEMS

The rousseau Modular Drawer

With a new design and improved performance, the Rousseau Modular Drawer is the best in its category. It permits faster inventory and ensures greater efficiency. In fact, it is the base of a storage system which offers top performance with a minimum investment.



The full-length handle is designed to provide a good solid grip, even when you open a drawer carrying 400 pounds. Installed at the top of the drawer, it is easier to reach, especially with bottom drawers. The full length handle serves to clearly identify contents since it matches the inside width of the drawer exactly. An optional non-reflective plastic cover ensures better visibility and protects the label.

Choose the colour of the handle end caps to suit your working environment and enhance your drawers and cabinets. Whether your work space is dark or bright, you can choose from colour combinations appropriate for industrial, commercial or institutional work places.



A wide selection of drawer depths and partitioning configuration allows users to design their units to accommodate a variety of inventory.

This feature increases efficiency in inventory management and keeps items in a clean, organized environment. Optional on all units is a locking system.



rousseau MODULAR DRAWER SYSTEMS

Heavy-Duty Cabinet Housings

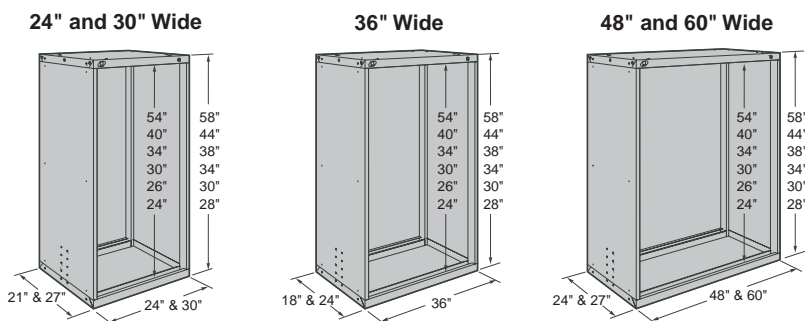

Available Heights

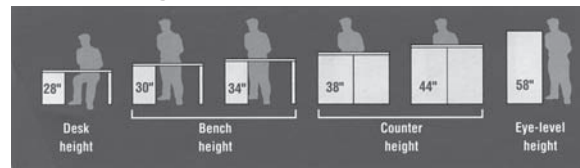

Drawer Dimensions

INSIDE DEPTH	INSIDE WIDTH					
	20"	26"	32"	38"	44"	56"
24"	24"x27"	30"x27"	36"x27"	42"x27"	48"x27"	60"x27"
18"	24"x24"	30"x24"	36"x24"	42"x24"	48"x24"	60"x24"
15"	24"x21"	30"x21"	36"x18"	42"x18"	48"x18"	

Drawer and Roll-Out Shelf Dimensions

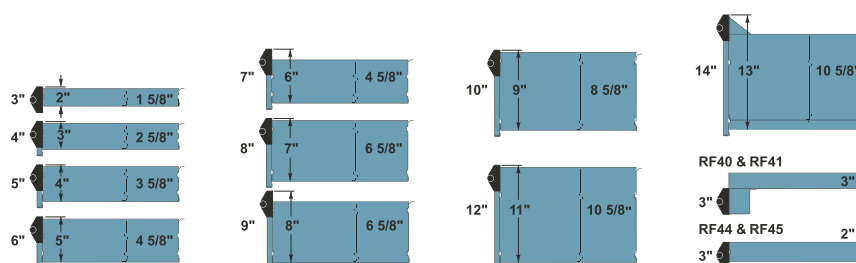

Compartment Dimensions

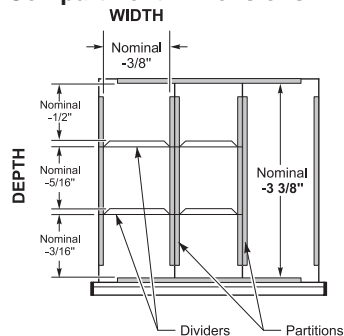

Cabinet Width x Depth

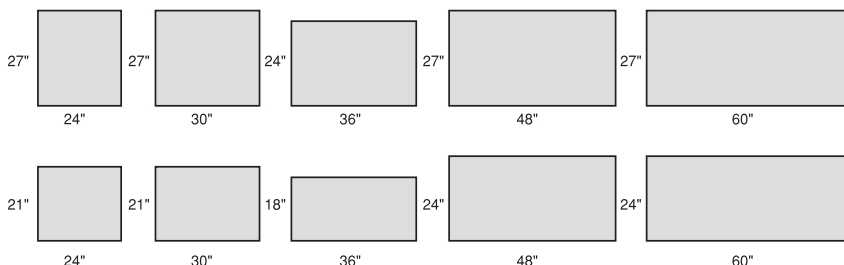

Front Access Forklift Base

RA52

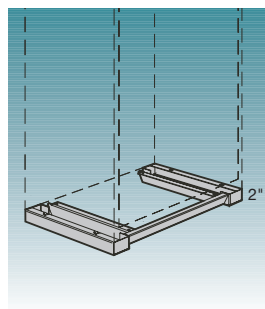

2" high base designed for moving the cabinet from the front with a forklift ;

Front cover plate included ;

Includes a recessed kick-plate in the center of the cabinet to allow user to stand closer to cabinet ;

Designed to enable user to anchor cabinet to the floor ;

Compatible with RA74 levelling glides ;

Compatible with the RA54 rear base cover plate, offered as an option.

Note : Not compatible with casters.

Note : Not designed for stacking applications.

Front and Side Access Forklift Base

RA53

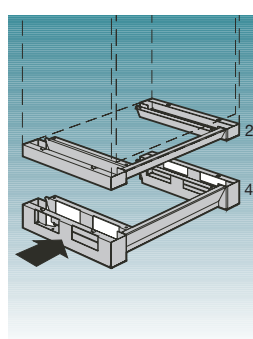

4" high base designed for moving the cabinet from the front or side with a forklift, or from the front with a pallet-jack ;

Front cover plate included ;

Includes a recessed kick-plate in the center of the cabinet to allow user to stand closer to cabinet ;

Designed to enable user to anchor cabinet to the floor ;

Compatible with RA74 levelling glides ;

Compatible with the RA54 rear base cover plate, offered as an option.

Note : Not compatible with casters.

Note : Not designed for stacking applications.



rousseau MODULAR DRAWER SYSTEMS

You can have your own custom-made cabinet, using the Rousseau options, which will meet all your needs.

A. Steel cabinet top with a rubber mat

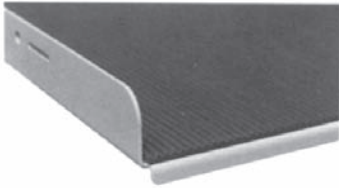

B. Laminated cabinet wood top



C. Doors



D. One-drawer-at-a-time locking mechanism

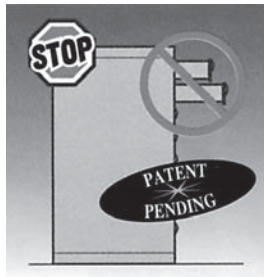

E. Individual drawer lock

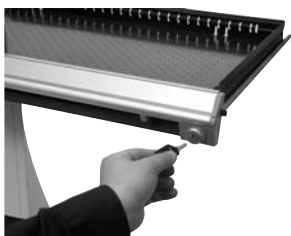

A&B Use your cabinet as a workbench or work surface. Tops protect cabinet surface. Steel tops with rubber mats, laminated wood tops and composition core tops are available.

C. Especially for cabinets with fixed or roll-out shelves. Doors protect against dust, theft and damage. Includes a locking mechanism. Please specify required type of keying* when ordering.

D. Prevents simultaneous opening of drawers to provide more stability to cabinet. Available on all models.

E. Provides added protection for limited access to all drawers.

F. Move entire contents in a single step. Includes a handle, rigid or swivel casters (with brakes).

G. Prevents accidental opening or closing of drawers in mobile units, vehicles or carousels. Factory installed on every drawer. Installation on site is also possible*

*With minor modifications to the drawer.

H. Allows ganglocking drawers in cabinets or shelving units. Ensures greater safety in vehicle applications. Can be used with a padlock (not included). Right-hand side application only. Fits most shelving units.

I. Ensures limited access to cabinet contents. Rousseau offers:
Key alike combinations (KA)*
Keys different (KD)*
Master keys (MK)*

F. Mobile cabinet



G. Lock-in / lock-out system



H. Vertical security bar



I. Cabinet lock





rousseau MODULAR DRAWER SYSTEMS

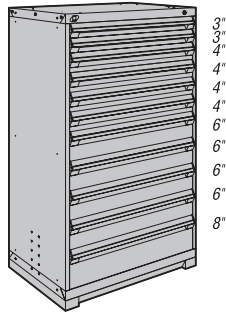

11 drawers
R5AEC-5803 36" x 18" x 60"
R5AEE-5803 36" x 24" x 60"

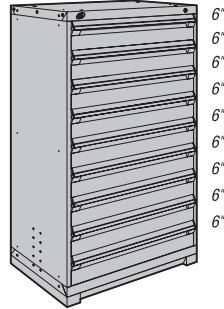

9 drawers
R5AEC-5813 36" x 18" x 60"
R5AEE-5813 36" x 24" x 60"

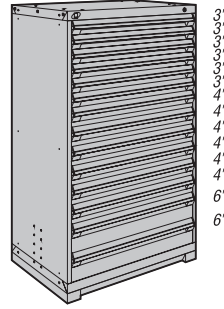

14 drawers
R5AEC-5817 36" x 18" x 60"
R5AEE-5817 36" x 24" x 60"

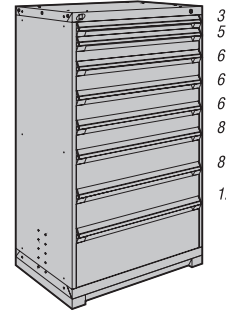

8 drawers
R5AEC-5825 36" x 18" x 60"
R5AEE-5825 36" x 24" x 60"

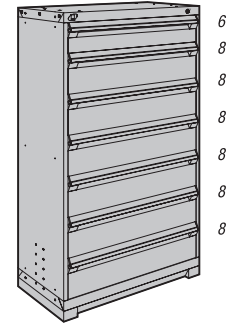

7 drawers
R5AEC-5833 36" x 18" x 60"
R5AEE-5833 36" x 24" x 60"

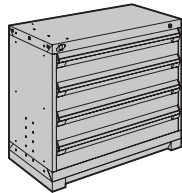

4 drawers
R5AEC-2801 36" x 18" x 30"
R5AEE-2801 36" x 24" x 30"

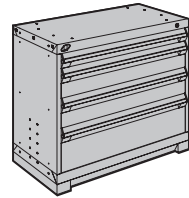

4 drawers
R5AEC-2803 36" x 18" x 30"
R5AEE-2803 36" x 24" x 30"

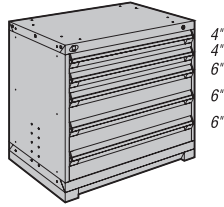

5 drawers
R5AEC-3005 36" x 18" x 32"
R5AEE-3005 36" x 24" x 32"

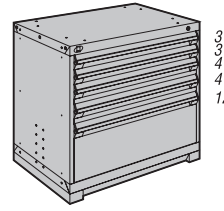

5 drawers
R5AEC-3011 36" x 18" x 32"
R5AEE-3011 36" x 24" x 32"

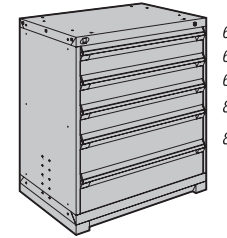

5 drawers
R5AEC-3805 36" x 18" x 40"
R5AEE-3805 36" x 24" x 40"

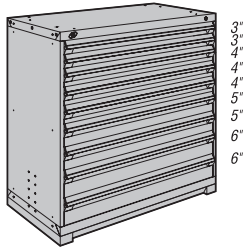

9 drawers
R5AHE-4405 48" x 24" x 46"
R5AHG-4405 48" x 27" x 46"

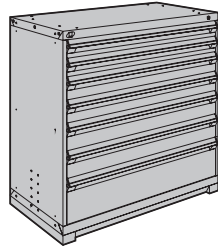

7 drawers
R5AHE-4407 48" x 24" x 46"
R5AHG-4407 48" x 27" x 46"

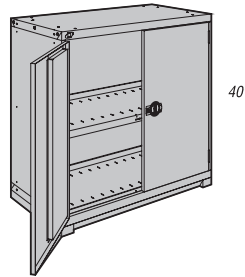

Double door / 1 adjustable shelf / 1 bottom shelf
R5AHE-4414 48" x 24" x 46"
R5AHG-4414 48" x 27" x 46"

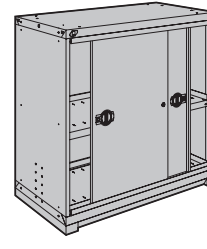

1 sliding door / 1 adjustable shelf / 1 bottom shelf
R5AHE-4416 48" x 24" x 46"
R5AHG-4416 48" x 27" x 46"

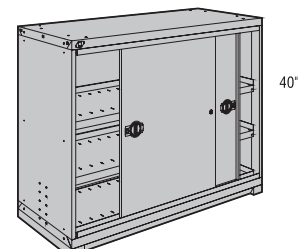

1 sliding door / 2 adjustable shelves / 1 bottom shelf
R5AKE-4406 60" x 24" x 46"
R5AKG-4406 60" x 27" x 46"

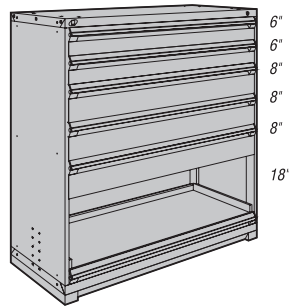

5 drawers / 1 roll-out shelf
R5AKE-5801 60" x 24" x 60"
R5AKG-5801 60" x 27" x 60"

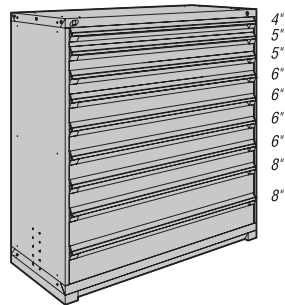

9 drawers
R5AKE-5803 60" x 24" x 60"
R5AKG-5803 60" x 27" x 60"

Shown here are several of the more popular heavy-duty modular cabinet models.

All proposals include a 2" front-access forklift base and a lock on the cabinet housing or on the door.

Drawer partitions are included in models.

Number of compartments (layout code)

Drawer dimensions	36" x 18"	36" x 24"	48" x 24"	48" x 27"	60" x 24"	60" x 27"
3" to 5"	24 (0518)	30 (0524)	40 (0732)	32 (0724)	70 (1356)	84 (1370)
6" to 8"	8 (0304)	12 (0308)	15 (0410)	15 (0410)	24 (0716)	21 (0614)
9" and higher	6 (0203)	9 (0206)	8 (0304)	8 (0304)	12 (0308)	12 (0308)



rousseau MODULAR DRAWER SYSTEMS

STORAGE VERSATILITY AT ITS BEST

Unite conventional and high density storage by incorporating modular drawers into the Spider shelving system. Combining Rousseau's Spider shelving and modular drawers results in an extremely flexible and highly versatile storage system.

Advantages of the Rousseau Drawer

- 100% access to content
- 400-pound load capacity
- Quiet, precise rolling
- Neat, modern design
- Ergonomics, cleanliness and safety
- Major space saver
- Progressive and modular system

Storage Systems with Drawers

Advantages, such as savings in space, time and efficiency, of a storage system become apparent through utilization. Criteria of a quality system are as follows:

- maximum use of available space.
- means to store items of various weight and size in an orderly, neat and safe fashion.
- easy to locate and access contents for use, filing and inventorying.
- reliable, quality construction.

The rousseau modular drawer system meets all these requirements. In addition, it can be adapted to specific needs simply by moving or adding drawers or drawer sections or by changing the partitioning.



Bulky items

Conventional storage

High density storage

Bulky and heavy items

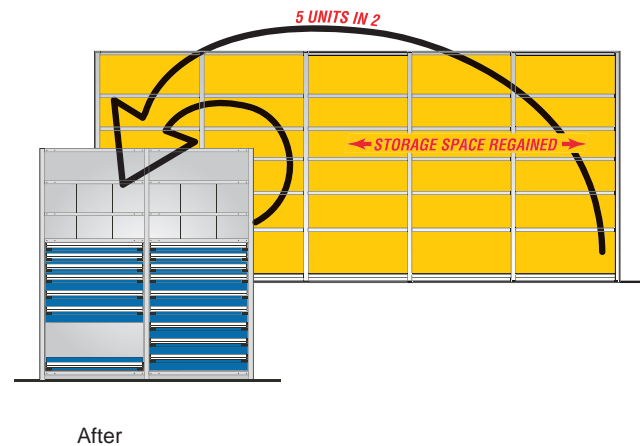
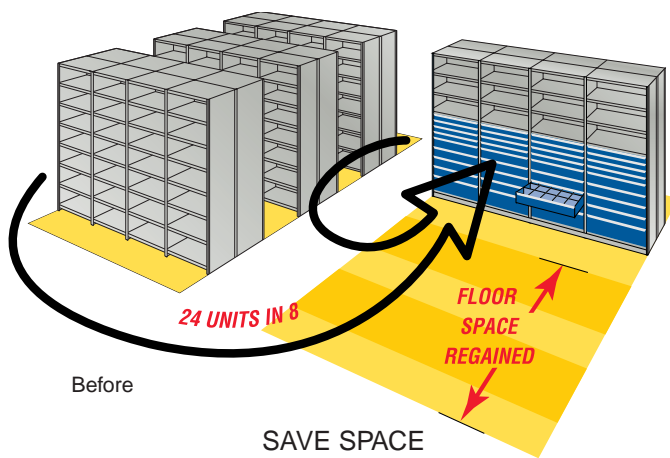

rousseau leads the North-American market in shelving units combined to modular drawers. With this hybrid system, small items can be stored in drawers while shelves are used for larger items. In addition, existing shelving units can be kept and their value increased by integrating them into a more versatile storage system. Also, your storage system can be adapted as your company expands simply by moving or adding drawers as needed.

Some of the posts compatible with our system :

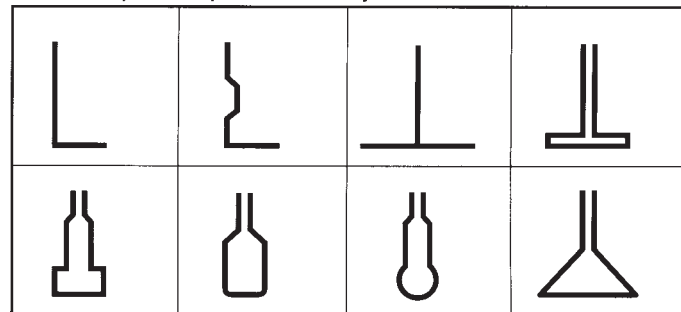



rousseau MODULAR DRAWER SYSTEMS

Presented here are some of the most popular modular drawer in shelving models.

Rousseau modular drawers are adaptable to more than 35 brands of shelving available on the market.

All models include mounting brackets for Spider® shelving. Please specify the shelving brand when ordering.

IMPORTANT



Drawer partitions are included in models.

For drawer proposals without partitions, refer to the price list.

NOTE Shelving must be ordered separately.

Number of Compartments (layout code)						
Drawer dimensions	36" x 18"	36" x 24"	42" x 18"	42" x 24"	48" x 18"	48" x 24"
3" to 5"	24 (0518)	30 (0524)	20 (0512)	30 (0524)	32 (0724)	40 (0732)
6" to 8"	8 (0304)	12 (0308)	12 (0308)	12 (0308)	10 (0405)	15 (0410)
9" and higher	6 (0203)	9 (0206)	6 (0203)	8 (0304)	8 (0304)	8 (0304)

18" H Bank of Drawers for Shelving



R5LEE-1801

- 4 drawers :
- 3-4" drawers
- 1-6" drawer

Product #	W x D
R5LEC-1801	36" x 18"
R5LEE-1801	36" x 24"
R5LGC-1801	42" x 18"
R5LGE-1801	42" x 24"
R5LHC-1801	48" x 18"
R5LHE-1801	48" x 24"

Note : Shelving must be ordered separately.

24" H Bank of Drawers for Shelving



R5LEE-2401

- 5 drawers :
- 3-4" drawers
- 2-6" drawers

Product #	W x D
R5LEC-2401	36" x 18"
R5LEE-2401	36" x 24"
R5LGC-2401	42" x 18"
R5LGE-2401	42" x 24"
R5LHC-2401	48" x 18"
R5LHE-2401	48" x 24"

Note : Shelving must be ordered separately.

36" H Bank of Drawers for Shelving



R5LEE-3601

- 7 drawers :
- 3-4" drawers
- 4-6" drawers

Product #	W x D
R5LEC-3601	36" x 18"
R5LEE-3601	36" x 24"
R5LGC-3601	42" x 18"
R5LGE-3601	42" x 24"
R5LHC-3601	48" x 18"
R5LHE-3601	48" x 24"

Note : Shelving must be ordered separately.



R5LEE-3603

- 7 drawers :
- 4-4" drawers
- 2-6" drawers
- 1-8" drawer

Product #	W x D
R5LEC-3603	36" x 18"
R5LEE-3603	36" x 24"
R5LGC-3603	42" x 18"
R5LGE-3603	42" x 24"
R5LHC-3603	48" x 18"
R5LHE-3603	48" x 24"

Note : Shelving must be ordered separately.



R5SEE-874811



Shelving with drawers must be anchored to the floor.

48" H Bank of Drawers for Shelving



R5LEE-4801

- 8 drawers :
- 8-6" drawers

Product #	W x D
R5LEC-4801	36" x 18"
R5LEE-4801	36" x 24"
R5LGC-4801	42" x 18"
R5LGE-4801	42" x 24"
R5LHC-4801	48" x 18"
R5LHE-4801	48" x 24"

Note : Shelving must be ordered separately.



R5LEE-4803

- 9 drawers :
- 4-4" drawers
- 4-6" drawers
- 1-8" drawer

Product #	W x D
R5LEC-4803	36" x 18"
R5LEE-4803	36" x 24"
R5LGC-4803	42" x 18"
R5LGE-4803	42" x 24"
R5LHC-4803	48" x 18"
R5LHE-4803	48" x 24"

Note : Shelving must be ordered separately.



R5LEE-4805

- 10 drawers :
- 6-4" drawers
- 4-6" drawers

Product #	W x D
R5LEC-4805	36" x 18"
R5LEE-4805	36" x 24"
R5LGC-4805	42" x 18"
R5LGE-4805	42" x 24"
R5LHC-4805	48" x 18"
R5LHE-4805	48" x 24"

Note : Shelving must be ordered separately.



R5LEE-4809

- 7 drawers and 1 front access roll-out shelf :
- 2-3" drawers
- 3-4" drawers
- 2-6" drawers

Product #	W x D
R5LEC-4809	36" x 18"
R5LEE-4809	36" x 24"
R5LGC-4809	42" x 18"
R5LGE-4809	42" x 24"
R5LHC-4809	48" x 18"
R5LHE-4809	48" x 24"

Note : Shelving must be ordered separately.



R5LEE-4807

- 11 drawers :
- 4-3" drawers
- 3-4" drawers
- 4-6" drawers

Product #	W x D
R5LEC-4807	36" x 18"
R5LEE-4807	36" x 24"
R5LGC-4807	42" x 18"
R5LGE-4807	42" x 24"
R5LHC-4807	48" x 18"
R5LHE-4807	48" x 24"

Note : Shelving must be ordered separately.

